



**成都戴梦迪超硬工具有限责任公司**

地址:成都青羊区蛟龙工业港黄海路 3 座 邮编:610091  
工厂电话:028-87075862/87073551 工厂传真:028-87075870  
公司电话:028-85407188 公司传真:028-85407188

Http://www.cddmd.com  
E-mail:dmd@cddmd.com

**CHENGDU DIAMOND TOOLS CO.,LTD.**

ADD:Building 3 HuangHai Road JiaoLong Industry  
Port of Qingyang District,Chengdu,China  
POST:610091  
TEL:0086-28-87075862/87073551/85407188  
FAX:0086-28-87075870/85407188

阳光·尚美设计制作 TEL:86433380

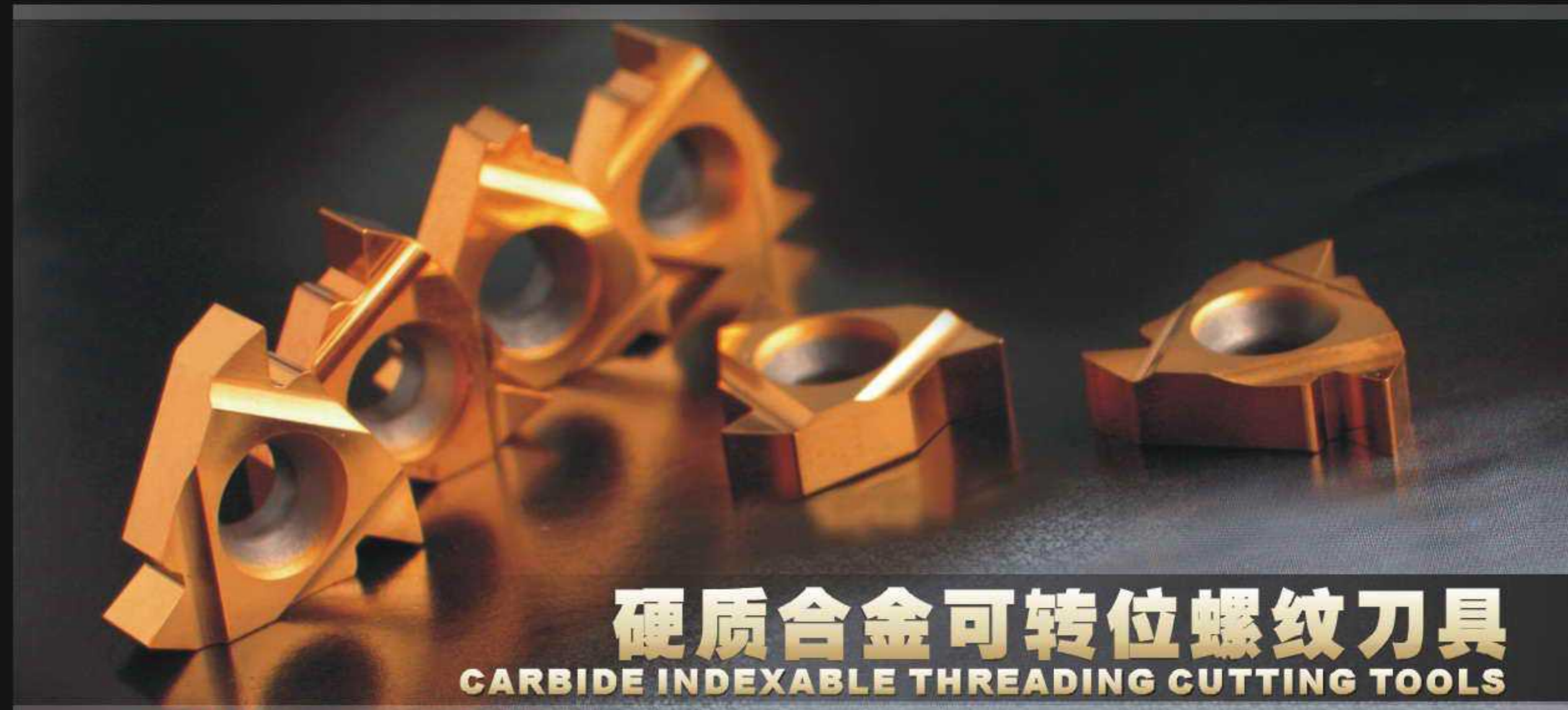

**硬质合金可转位螺纹刀具**  
CARBIDE INDEXABLE THREADING CUTTING TOOLS



**成都戴梦迪超硬工具有限责任公司**  
CHENGDU DIAMOND TOOLS CO.,LTD

# 公司简介

成都戴梦迪超硬工具有限责任公司是专业生产CBN/PCD超硬刀具、硬质合金成型刀具的民营企业。公司生产的硬质合金可转位螺纹刀具以其精度高、寿命长、稳定性好、价格合理等特点深受用户好评，尤其适合于不锈钢、铸铁、高强度钢及有色金属等材料的高效精密螺纹加工。已在很多生产线上替代了进口螺纹刀具，产品有：60°通用型螺纹；55°通用型螺纹；ISO标准型螺纹；UN统一标准螺纹；W英国惠氏螺纹；BSPT英国55°管螺纹；NPT美国60°管螺纹；API美国石油管螺纹等，并能承接客户的特殊订货。

公司已通过ISO9001-2000质量管理体系认证。

Chengdu Diamond Tools Co. Ltd is a private enterprise specialized in CBN (Cubic Boron Nitride) / PCD (Polycrystalline Diamond) tools and Carbide profile cutting tools. The indexable threading cutting tools produced by the company are well known for their high precision, long tool life with reasonable price. The indexable threading cutting tools are suitable to cutting various kinds of metal such as stainless steel, cast iron, high strength steel and nonferrous metals. They have been sold to oversea market and enjoyed a good reputation. Threading products with different standards. e.g. Partial profile 60°, Partial profile 55°, ISO Metric, UN, Whitworth, BSPT, NPT, API threads etc. are supplied by the company.

The company has been granted with the ISO 9001-2000 Quality Certificate by CQM in China.



# CONTENTS 目录

## INDEXABLE THREADING INSERTS

### 一 螺纹刀片

#### 一般机械用

60° -- 通用型螺纹刀片	Partial Profile 60°	3
55° -- 通用型螺纹刀片	Partial Profile 55°	4
ISO --- 标准型螺纹刀片	ISO Metric full profile	5
UN ---- 60° 美制统一标准螺纹刀片	American UN full profile	7

#### 航空 宇航工业用

UNJ --- 60° 美制航空航天螺纹刀片	Aviation thread	9
------------------------	-----------------	---

#### 煤气 自来水龙头与管道连接用

W ----- 55° 英国惠氏螺纹刀片	55° Whitworth full profile	11
NPT --- 60° 美国标准锥管螺纹刀片	National Pipe Thread	13

#### 蒸汽 煤气 供水管螺纹

NPTF -- 60° 美制干密封螺纹刀片	NPTF	14
BSPT -- 55° 英国标准锥管螺纹刀片	British Standard pipe full profile	15

#### 机械驱动用

ACME -- 英制29° 梯形螺纹刀片	ACME	16
TR ---- 30° 标准梯形螺纹刀片	Trapeze DIN 103	17

#### ABUT ---- 美制锯齿形螺纹刀片 American Buttress | 18 |

#### RD ----- 食品消防机械圆螺纹刀片 Round (DIN 405) | 19 |

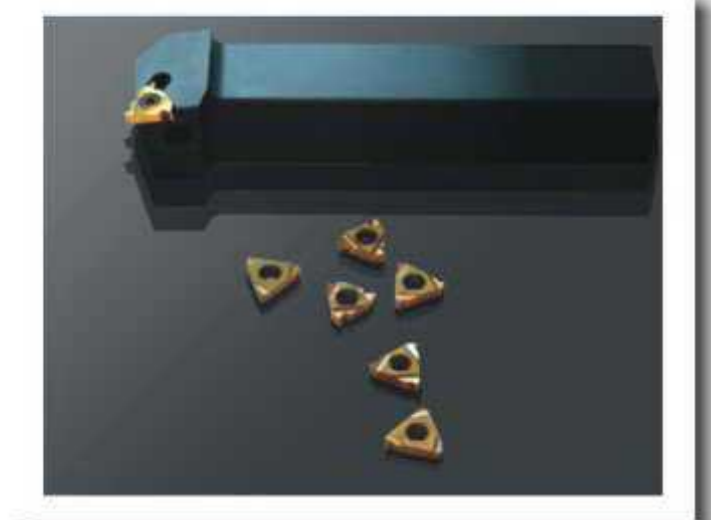
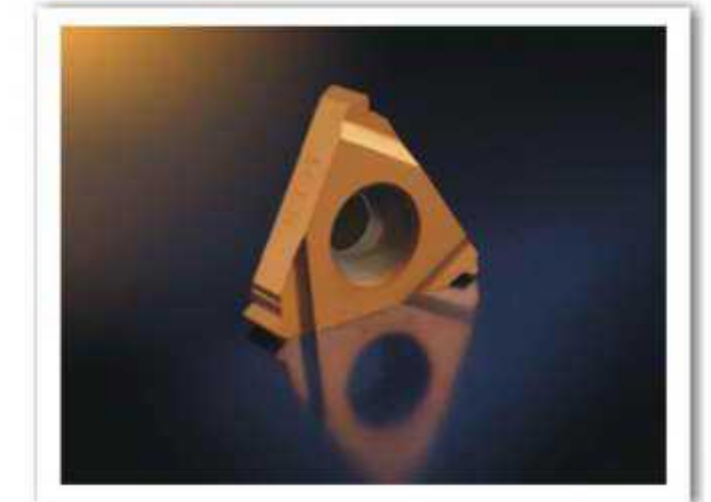

## THREADING TOOLS HOLDER

### 二 螺纹刀杆

外螺纹刀杆	External Threading Tool holder	20
-------	--------------------------------	----

内螺纹刀杆	Internal Threading Tool holder	21
-------	--------------------------------	----

### 螺纹切削速度的选择

被加工材料	M30 (m/min)	P30 (m/min)
低碳钢或中碳钢	80-130	80-140
高碳钢	60-110	60-120
合金钢或调质钢	60-110	60-120
不锈钢	60-100	
铸钢	60-110	60-120
铸铁	60-200	
铝合金或铜合金	90-280	



## 第一部分：螺纹刀片

### 可转位螺纹车刀刀片型号说明 (Threading Insert Identification System)

刀片尺寸 Insert Size		加工类型 Application		螺纹旋向 Hand of Thread	
L (mm)	D				
08	3/16"	E 外螺纹 External	External	R 右旋螺纹 Right Hand	Right Hand
11	1/4"				
16	3/8"				
22	1/2"	I 内螺纹 Internal	Internal	L 左旋螺纹 Left Hand	Left Hand
27	5/8"				

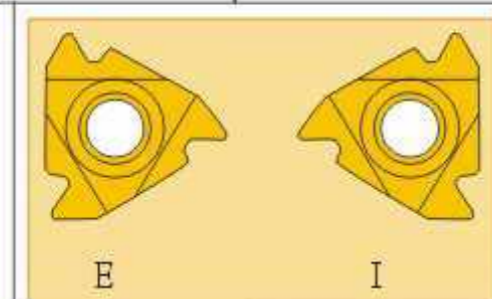
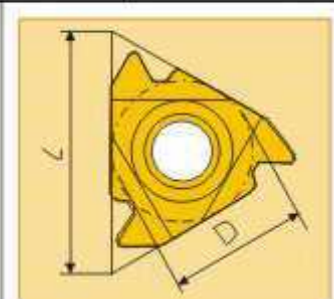

16 E R 1.5 ISO

螺距 Pitch		
完全形 Full Profile		
mm	TPI (牙数/英寸)	
0.5~6	48~4	
局部面截顶形 Partial Profile		
mm	TPI (牙数/英寸)	
A 0.5~1.5	48~16	
AG 0.5~3.0	48~8	
N 1.75~3.0	14~8	
Q 3.5~5.0	7~5	
	4.5~4	

螺距标准 Standard	
60	60° 通用型螺纹
55	55° 通用型螺纹
ISO	ISO 标准型螺纹
UN	60° 美制统一标准型螺纹
UNJ	60° 美制航空航天螺纹
W	55° 英国惠氏螺纹
NPT	60° 美国标准锥管螺纹
NPTF	60° 美制干密封螺纹
BSPT	55° 英制标准锥管螺纹
ACME	英制29° 梯形螺纹
TR	30° 标准梯形螺纹
ABUT	美制锯齿形螺纹
RD	消防食品机械园螺纹

## § 1-1. 一般机械用

### 1-1.1 60° 通用型螺纹刀片 (Partial Profile 60°)

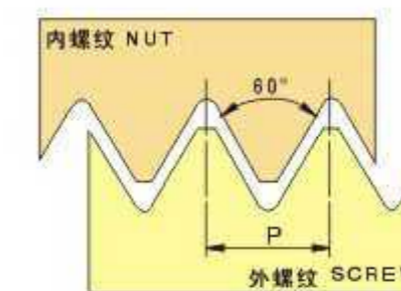
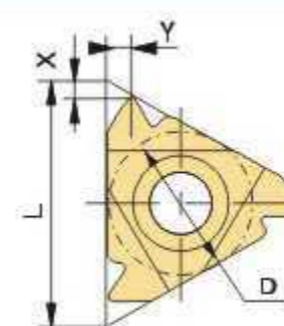

	D	加工螺距范围 Pitch		刀片型号 Designation		刀片尺寸 Dimension		
		mm	TPI	右旋螺纹 Right Hand	左旋螺纹 Left Hand	L	X	Y
外螺纹 External	1/4"	0.5~1.5	48~16	11ERA60	11ELA60	11	0.8	0.9
	3/8"	0.5~1.5	48~16	16ERA60	16ELA60	16	0.8	0.9
		0.5~3.0	48~8	16ERAG60	16ELAG60		1.2	1.7
		1.75~3.0	14~8	16ERG60	16ELG60		1.2	1.7
1/2"	3.5~5.0	7~5	22ERN60	22ELN60	22	1.7	2.5	
	5/8"	5.5~6.0	4.5~4	27ERQ60	27ELQ60	27	2.1	3.1
内螺纹 Internal	1/4"	0.5~1.5	48~16	11IRA60	11ILA60	11	0.8	0.9
	3/8"	0.5~1.5	48~16	16IRA60	16ILA60	16	0.8	0.9
		0.5~3.0	48~8	16IRAG60	16ILAG60		1.2	1.7
		1.75~3.0	14~8	16IRG60	16ILG60		1.2	1.7
1/2"	3.5~5.0	7~5	22IRN60	22ILN60	22	1.7	2.5	
	5/8"	5.5~6.0	4.5~4	27IRQ60	27ILQ60	27	1.8	2.7

▲ 订货举例：16IRAG60 100片

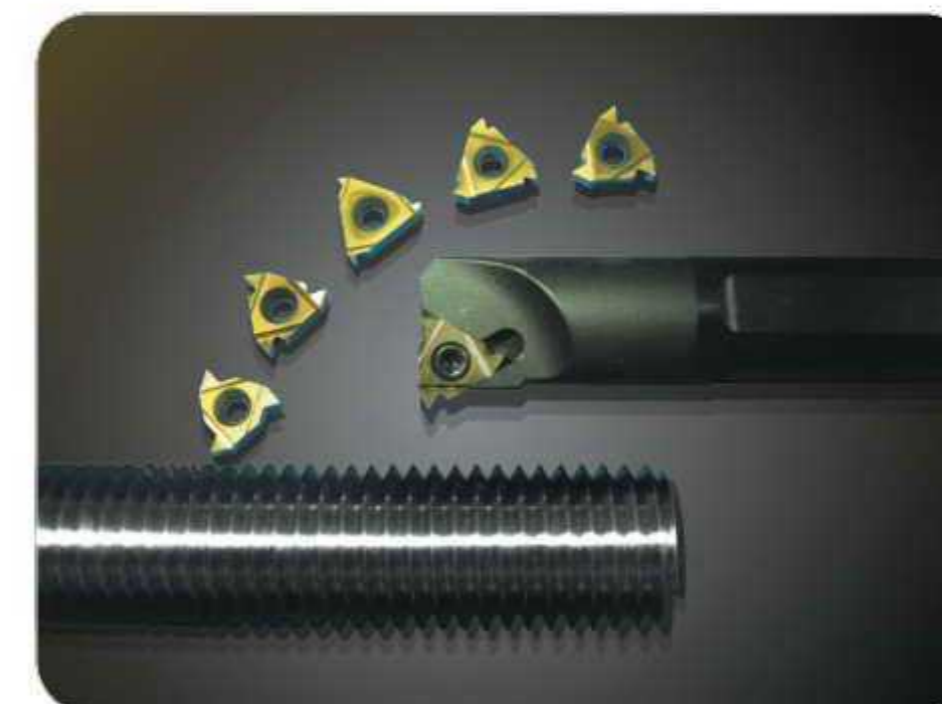

1-1.2 55° 通用型螺纹刀片 (Partial Profile 55°)

1-1.3 ISO标准型螺纹刀片 (ISO Metric full profile)

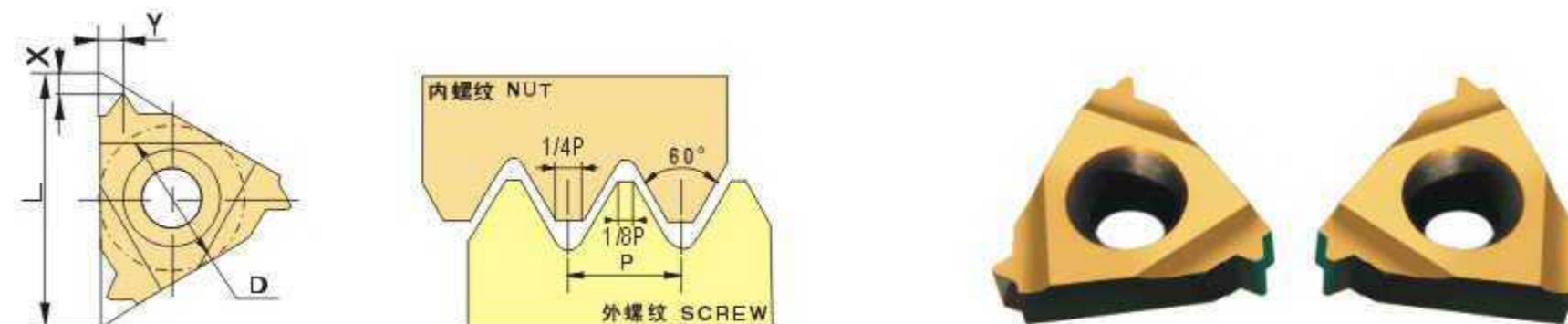
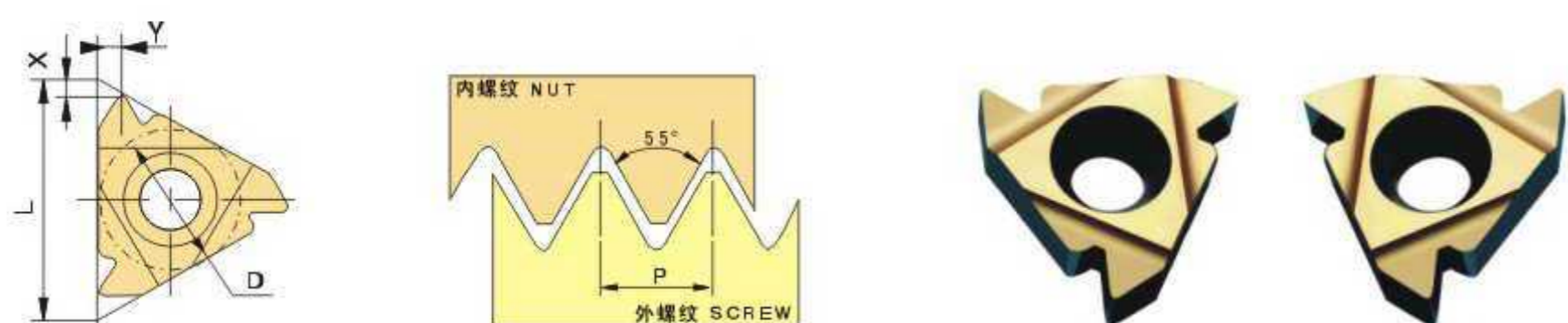

	D	加工螺距范围 Pitch		刀片型号 Designation		刀片尺寸 Dimension		
		mm	TPI	右旋螺纹 Right Hand	左旋螺纹 Left Hand	L	X	Y
外螺纹 External	1/4"	0.5~1.5	48~16	11ER A55	11EL A55	11	0.8	0.9
	3/8"	0.5~1.5	48~16	16ER A55	16EL A55	16	0.8	0.9
		0.5~3.0	48~8	16ER AG55	16EL AG55		1.2	1.7
		1.75~3.0	14~8	16ER G55	16EL G55		1.2	1.7
	1/2"	3.5~5.0	7~5	22ER N55	22EL N55	22	1.7	2.5
5/8"	5.5~6.0	4.5~4	27ER Q55	27EL Q55	27	2.0	2.9	
内螺纹 Internal	1/4"	0.5~1.5	48~16	11IR A55	11IL A55	11	0.8	0.9
	3/8"	0.5~1.5	48~16	16IR A55	16IL A55	16	0.8	0.9
		0.5~3.0	48~8	16IR AG55	16IL AG55		1.2	1.7
		1.75~3.0	14~8	16IR G55	16IL G55		1.2	1.7
	1/2"	3.5~5.0	7~5	22IR N55	22IL N55	22	1.7	2.5
5/8"	5.5~6.0	4.5~4	27IR Q55	27IL Q55	27	2.0	2.9	

▲ 订货举例: 16ER AG 55 100片



	D	加工螺距 Pitch	刀片型号 Designation		刀片尺寸 Dimension		
		mm	右旋螺纹 Right Hand	左旋螺纹 Left Hand	L	X	Y
外螺纹 External	1/4"	0.50	11ER0.50 ISO	11EL0.50 ISO	11	0.6	0.6
		0.75	11ER0.75 ISO	11EL0.75 ISO		0.6	0.6
		1.00	11ER1.00 ISO	11EL1.00 ISO		0.7	0.7
		1.25	11ER1.25 ISO	11EL1.25 ISO		0.8	0.9
		1.50	11ER1.50 ISO	11EL1.50 ISO		0.8	1.0
		1.75	11ER1.75 ISO	11EL1.75 ISO		0.8	1.1
	3/8"	0.50	16ER0.50 ISO	16EL0.50 ISO	16	0.6	0.6
		0.75	16ER0.75 ISO	16EL0.75 ISO		0.6	0.7
		1.00	16ER1.00 ISO	16EL1.00 ISO		0.7	0.8
		1.25	16ER1.25 ISO	16EL1.25 ISO		0.8	0.9
		1.50	16ER1.50 ISO	16EL1.50 ISO		0.8	1.0
		1.75	16ER1.75 ISO	16EL1.75 ISO		0.9	1.2
		2.00	16ER2.00 ISO	16EL2.00 ISO		1.0	1.3
		2.50	16ER2.50 ISO	16EL2.50 ISO		1.1	1.5
	1/2"	3.50	22ER3.50 ISO	22EL3.50 ISO	22	1.6	2.3
		4.00	22ER4.00 ISO	22EL4.00 ISO		1.6	2.3
		4.50	22ER4.50 ISO	22EL4.50 ISO		1.7	2.4
		5.00	22ER5.00 ISO	22EL5.00 ISO		1.7	2.5
		5.50	27ER5.50 ISO	27EL5.50 ISO		27	1.9
	6.00	27ER6.00 ISO	27EL6.00 ISO	2.0	2.9		

▲ 订货举例: 16ER1.25 ISO 100片

1-1.4 60° 美制统一标准螺纹刀片 (American UN full profile)

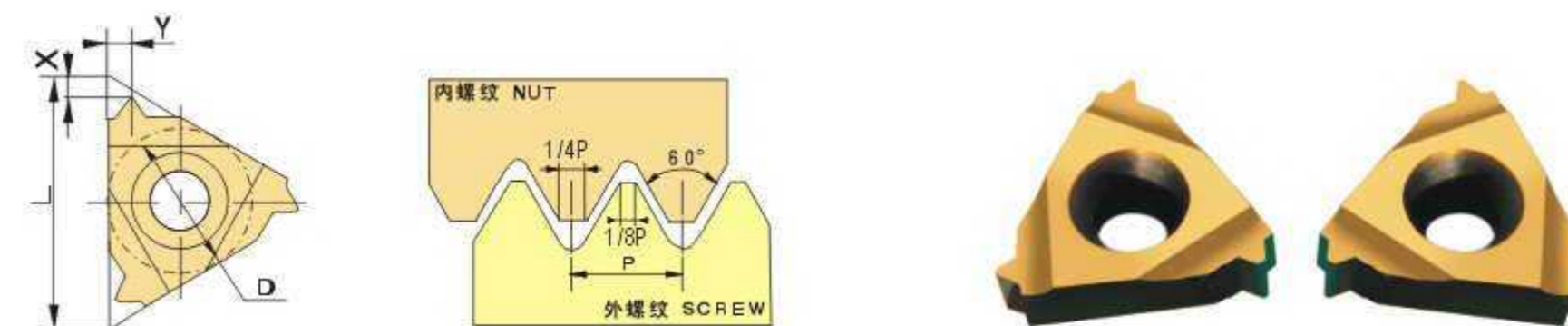
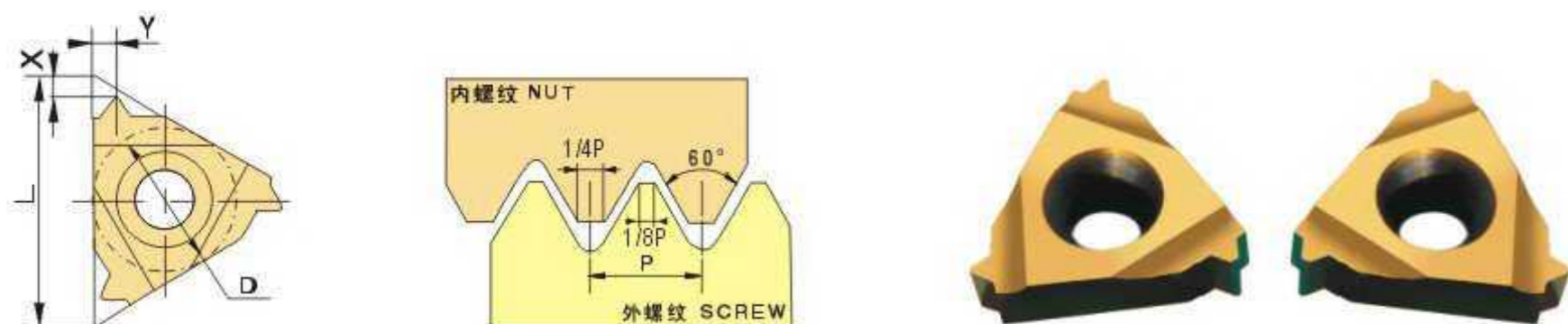

	D	加工螺距 Pitch	刀片型号 Designation		刀片尺寸 Dimension				
		mm	右旋螺纹 Right Hand	左旋螺纹 Left Hand	L	X	Y		
		1/4"	0.50	11IR0.50 ISO	11IL0.50 ISO	11	0.6	0.6	
	0.75	11IR0.75 ISO	11IL0.75 ISO	0.6	0.6				
	1.00	11IR1.00 ISO	11IL1.00 ISO	0.6	0.7				
	1.25	11IR1.25 ISO	11IL1.25 ISO	0.8	0.9				
	1.50	11IR1.50 ISO	11IL1.50 ISO	0.8	1.0				
	1.75	11IR1.75 ISO	11IL1.75 ISO	0.9	1.1				
	2.00	11IR2.00 ISO	11IL2.00 ISO	1.0	1.3				
	2.50	11IR2.50 ISO	11IL2.50 ISO	1.1	1.5				
内螺纹 Internal	3/8"	0.50	16IR0.50 ISO	16IL0.50 ISO	16	0.6	0.6		
		0.75	16IR0.75 ISO	16IL0.75 ISO		0.6	0.6		
		1.00	16IR1.00 ISO	16IL1.00 ISO		0.6	0.7		
		1.25	16IR1.25 ISO	16IL1.25 ISO		0.8	0.9		
		1.50	16IR1.50 ISO	16IL1.50 ISO		0.8	1.0		
		1.75	16IR1.75 ISO	16IL1.75 ISO		0.9	1.2		
		2.00	16IR2.00 ISO	16IL2.00 ISO		1.0	1.3		
		2.50	16IR2.50 ISO	16IL2.50 ISO		1.1	1.5		
	1/2"	3.00	16IR3.00 ISO	16IL3.00 ISO	22	1.1	1.5		
		3.50	22IR3.50 ISO	22IL3.50 ISO		1.6	2.3		
		4.00	22IR4.00 ISO	22IL4.00 ISO		1.6	2.3		
		4.50	22IR4.50 ISO	22IL4.50 ISO		1.6	2.4		
		5.00	22IR5.00 ISO	22IL5.00 ISO		1.6	2.5		
		5/8"	5.50	27IR5.50 ISO		27IL5.50 ISO	27	1.9	2.7
			6.00	27IR6.00 ISO		27IL6.00 ISO		2.0	2.9

▲ 订货举例: 16IR1.25 ISO 100片

	D	加工螺距 Pitch	刀片型号 Designation		刀片尺寸 Dimension			
		TPI	右旋螺纹 Right Hand	左旋螺纹 Left Hand	L	X	Y	
		1/4"	32	11ER32 UN	11EL32 UN	11	0.6	0.6
	28	11ER28 UN	11EL28 UN	0.6	0.7			
	24	11ER24 UN	11EL24 UN	0.7	0.8			
	20	11ER20 UN	11EL20 UN	0.8	0.9			
	18	11ER18 UN	11EL18 UN	0.8	1.0			
	16	11ER16 UN	11EL16 UN	0.9	1.1			
外螺纹 External	3/8"	32	16ER32 UN	16EL32 UN	16	0.6	0.6	
		28	16ER28 UN	16EL28 UN		0.6	0.7	
		24	16ER24 UN	16EL24 UN		0.7	0.8	
		20	16ER20 UN	16EL20 UN		0.8	0.9	
		18	16ER18 UN	16EL18 UN		0.8	1.0	
		16	16ER16 UN	16EL16 UN		0.9	1.1	
		14	16ER14 UN	16EL14 UN		1.0	1.2	
		13	16ER13 UN	16EL13 UN		1.1	1.3	
	1/2"	12	16ER12 UN	16EL12 UN	22	1.1	1.4	
		11.5	16ER11.5 UN	16EL11.5 UN		1.1	1.4	
		11	16ER11 UN	16EL11 UN		1.1	1.5	
		10	16ER10 UN	16EL10 UN		1.1	1.5	
		9	16ER9 UN	16EL9 UN		1.2	1.7	
		8	16ER8 UN	16EL8 UN		1.2	2.0	
		7	22ER7 UN	22EL7 UN		22	1.6	2.3
		6	22ER6 UN	22EL6 UN			1.6	2.3
5/8"	5	22ER5 UN	22EL5 UN	27	1.7	2.5		
	4.5	27ER4.5 UN	27EL4.5 UN		1.9	2.7		
	4	27ER4 UN	27EL4 UN	2.1	3.0			

▲ 订货举例: 16ER 20 UN 100片

§ 1-2. 航空. 航天工业用

1-2.1 UNJ-美制航空航天机械螺纹刀片 (Aviation thread)

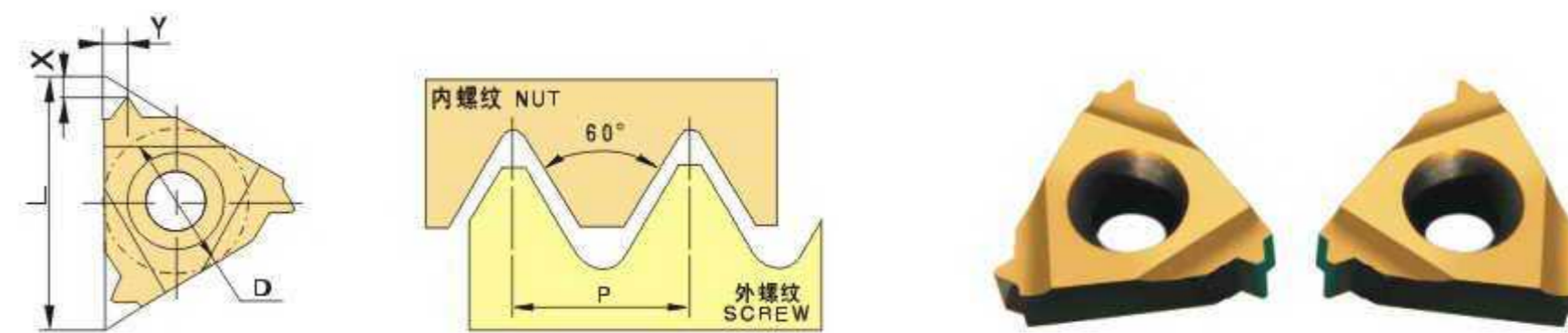
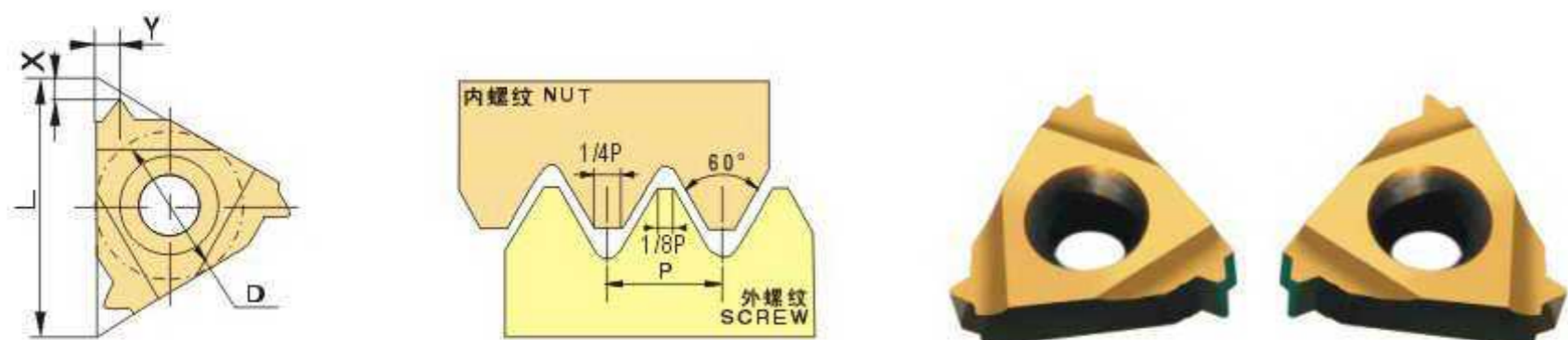

	D	加工螺距 Pitch		刀片型号 Designation		刀片尺寸 Dimension			
		TPI	右旋螺纹 Right Hand	左旋螺纹 Left Hand	L	X	Y		
内螺纹 Internal	1/4"	32	11IR32 UN	11IL32 UN	11	0.6	0.6		
		28	11IR28 UN	11IL28 UN		0.6	0.7		
		24	11IR24 UN	11IL24 UN		0.7	0.8		
		20	11IR20 UN	11IL20 UN		0.8	0.9		
		18	11IR18 UN	11IL18 UN		0.8	1.0		
		16	11IR16 UN	11IL16 UN		0.9	1.1		
	3/8"	32	16IR32 UN	16IL32 UN	16	0.6	0.6		
		28	16IR28 UN	16IL28 UN		0.6	0.7		
		24	16IR24 UN	16IL24 UN		0.7	0.8		
		20	16IR20 UN	16IL20 UN		0.8	0.9		
		18	16IR18 UN	16IL18 UN		0.8	1.0		
		16	16IR16 UN	16IL16 UN		0.9	1.1		
		5/8"	14	16IR14 UN		16IL14 UN	16	1.0	1.2
			13	16IR13 UN		16IL13 UN		1.0	1.3
			12	16IR12 UN		16IL12 UN		1.1	1.4
			11	16IR11 UN		16IL11 UN		1.1	1.5
			10	16IR10 UN		16IL10 UN		1.1	1.5
			9	16IR9 UN		16IL9 UN		1.2	1.7
1/2"	8	16IR8 UN	16IL8 UN	22	1.2	2.0			
	7	22IR7 UN	22IL7 UN		1.6	2.3			
	6	22IR6 UN	22IL6 UN		1.6	2.3			
	5	22IR5 UN	22IL5 UN		1.7	2.5			
5/8"	4.5	27IR4.5 UN	27IL4.5 UN	27	1.9	2.7			
	4	27IR4 UN	27IL4 UN		2.1	3.0			

▲ 订货举例: 16IR 20 UN 100片

	D	加工螺距 Pitch		刀片型号 Designation		刀片尺寸 Dimension			
		TPI	右旋螺纹 Right Hand	左旋螺纹 Left Hand	L	X	Y		
外螺纹 External	1/4"	28	11ER 28 UNJ	11EL 28 UNJ	11	0.7	0.7		
		24	11ER 24 UNJ	11EL 24 UNJ		0.7	0.8		
		20	11ER 20 UNJ	11EL 20 UNJ		0.8	0.9		
		18	11ER 18 UNJ	11EL 18 UNJ		0.8	1.0		
		16	11ER 16 UNJ	11EL 16 UNJ		0.9	1.1		
		14	11ER 14 UNJ	11EL 14 UNJ		1.0	1.2		
	3/8"	28	16ER 28 UNJ	16EL 28 UNJ	16	0.7	0.7		
		24	16ER 24 UNJ	16EL 24 UNJ		0.7	0.8		
		20	16ER 20 UNJ	16EL 20 UNJ		0.8	0.9		
		18	16ER 18 UNJ	16EL 18 UNJ		0.8	1.0		
		16	16ER 16 UNJ	16EL 16 UNJ		0.9	1.1		
		14	16ER 14 UNJ	16EL 14 UNJ		1.0	1.2		
		5/8"	13	16ER 13 UNJ		16EL 13 UNJ	16	1.0	1.3
			12	16ER 12 UNJ		16EL 12 UNJ		1.1	1.3
			11	16ER 11 UNJ		16EL 11 UNJ		1.2	1.5
			10	16ER 10 UNJ		16EL 10 UNJ		1.2	1.5
			9	16ER 9 UNJ		16EL 9 UNJ		1.3	1.7
			8	16ER 8 UNJ		16EL 8 UNJ		1.2	1.6
	1/2"	7	22ER 7 UNJ	22EL 7 UNJ	22	1.7	2.3		
		6	22ER 6 UNJ	22EL 6 UNJ		1.6	2.3		
		5	22ER 5 UNJ	22EL 5 UNJ		1.8	2.5		
	5/8"	4.5	27ER 4.5 UNJ	27EL 4.5 UNJ	27	2.0	2.7		
		4	27ER 4 UNJ	27EL 4 UNJ		2.2	3.0		

▲ 订货举例: 16ER 20 UNJ 100片

§ 1-3. 煤气、自来水龙头与管道连接用

1-3.1 55° 英国惠氏螺纹刀片 (55° Whitworth full profile)

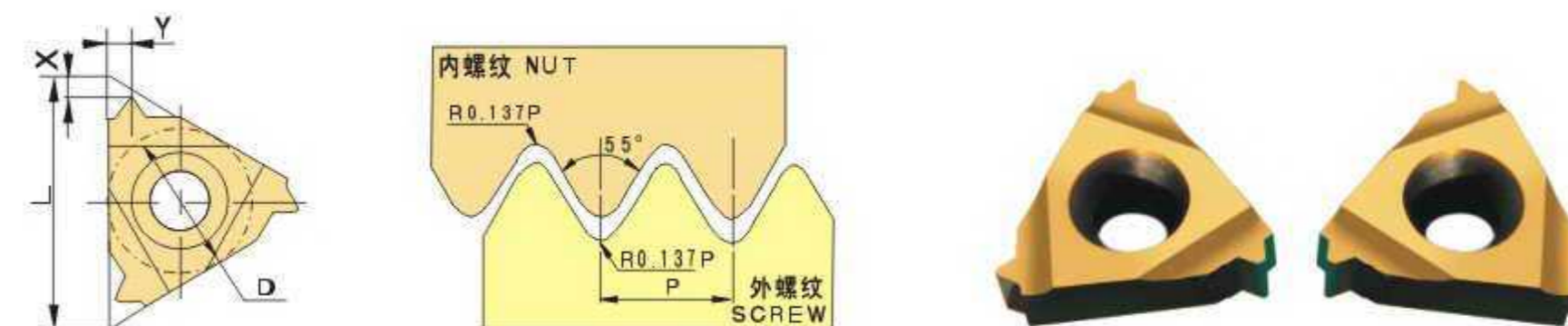
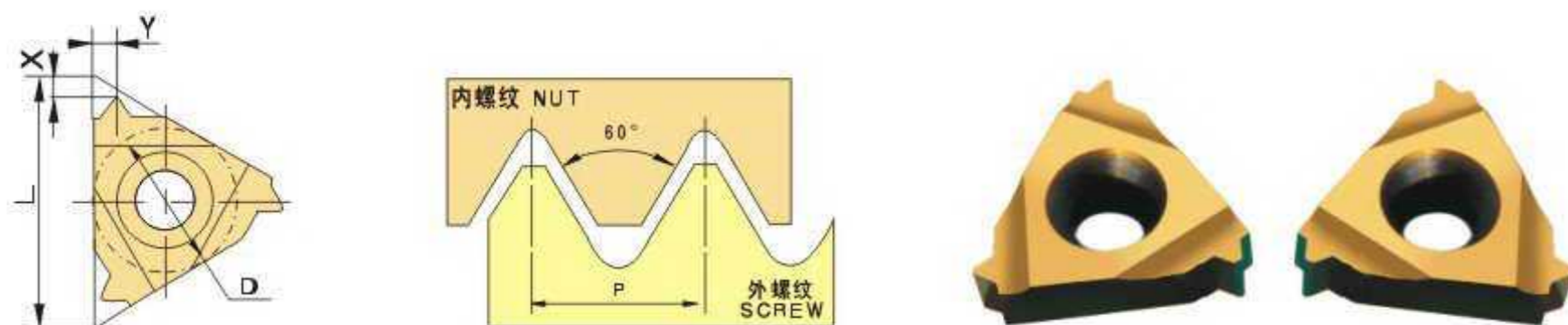

	D	加工螺距 Pitch	刀片型号 Designation		刀片尺寸 Dimension				
			TPI	右旋螺纹 Right Hand	左旋螺纹 Left Hand	L	X	Y	
内螺纹 Internal	1/4"	28	11IR 28 UNJ	11IL 28 UNJ	11	0.7	0.7		
		24	11IR 24 UNJ	11IL 24 UNJ		0.7	0.8		
		20	11IR 20 UNJ	11IL 20 UNJ		0.8	0.9		
		18	11IR 18 UNJ	11IL 18 UNJ		0.8	1.0		
		16	11IR 16 UNJ	11IL 16 UNJ		0.9	1.1		
		14	11IR 14 UNJ	11IL 14 UNJ		1.0	1.2		
	3/8"	28	16IR 28 UNJ	16IL 28 UNJ	16	0.7	0.7		
		24	16IR 24 UNJ	16IL 24 UNJ		0.7	0.8		
		20	16IR 20 UNJ	16IL 20 UNJ		0.8	0.9		
		18	16IR 18 UNJ	16IL 18 UNJ		0.8	1.0		
		16	16IR 16 UNJ	16IL 16 UNJ		0.9	1.1		
		14	16IR 14 UNJ	16IL 14 UNJ		1.0	1.2		
		13	16IR 13 UNJ	16IL 13 UNJ		1.0	1.3		
		12	16IR 12 UNJ	16IL 12 UNJ		1.1	1.3		
		11	16IR 11 UNJ	16IL 11 UNJ		1.2	1.5		
		10	16IR 10 UNJ	16IL 10 UNJ		1.2	1.5		
		9	16IR 9 UNJ	16IL 9 UNJ		1.3	1.7		
		8	16IR 8 UNJ	16IL 8 UNJ		1.2	1.6		
		1/2"	7	22IR 7 UNJ		22IL 7 UNJ	22	1.7	2.3
			6	22IR 6 UNJ		22IL 6 UNJ		1.6	2.3
5	22IR 5 UNJ		22IL 5 UNJ	1.8	2.5				
5/8"	4.5	27IR 4.5 UNJ	27IL 4.5 UNJ	27	2.0	2.7			
	4	27IR 4 UNJ	27IL 4 UNJ		2.2	3.0			

▲ 订货举例: 16IR 20 UNJ 100片

	D	加工螺距 Pitch	刀片型号 Designation		刀片尺寸 Dimension			
			TPI	右旋螺纹 Right Hand	左旋螺纹 Left Hand	L	X	Y
外螺纹 External	1/4"	28	11ER28 W	11EL28 W	11	0.6	0.7	
		26	11ER26 W	11EL26 W		0.7	0.8	
		20	11ER20 W	11EL20 W		0.8	0.9	
		19	11ER19 W	11EL19 W		0.8	1.0	
		18	11ER18 W	11EL18 W		0.8	1.0	
		16	11ER16 W	11EL16 W		0.9	1.1	
		14	11ER14 W	11EL14 W		1.0	1.2	
		14	11ER14 W	11EL14 W		1.0	1.2	
	3/8"	28	16ER28 W	16EL28 W	16	0.6	0.7	
		26	16ER26 W	16EL26 W		0.7	0.8	
		20	16ER20 W	16EL20 W		0.8	0.9	
		19	16ER19 W	16EL19 W		0.8	1.0	
		18	16ER18 W	16EL18 W		0.8	0.9	
		16	16ER16 W	16EL16 W		0.9	1.1	
		14	16ER14 W	16EL14 W		1.0	1.2	
		12	16ER12 W	16EL12 W		1.1	1.4	
		11	16ER11 W	16EL11 W		1.1	1.5	
		10	16ER10 W	16EL10 W		1.1	1.5	
		9	16ER9 W	16EL9 W		1.2	1.5	
		8	16ER8 W	16EL8 W		1.2	1.7	
	1/2"	7	22ER7 W	22EL7 W	22	1.6	2.3	
		6	22ER6 W	22EL6 W		1.6	2.3	
		5	22ER5 W	22EL5 W		1.7	2.4	
	5/8"	4.5	27ER4.5 W	27EL4.5 W	27	1.8	2.6	
		4	27ER4 W	27EL4 W		2.0	2.9	

▲ 订货举例: 16ER 16W 100片

1-3.2 60° 美国标准锥管螺纹刀片(Nation Pipe Threads)

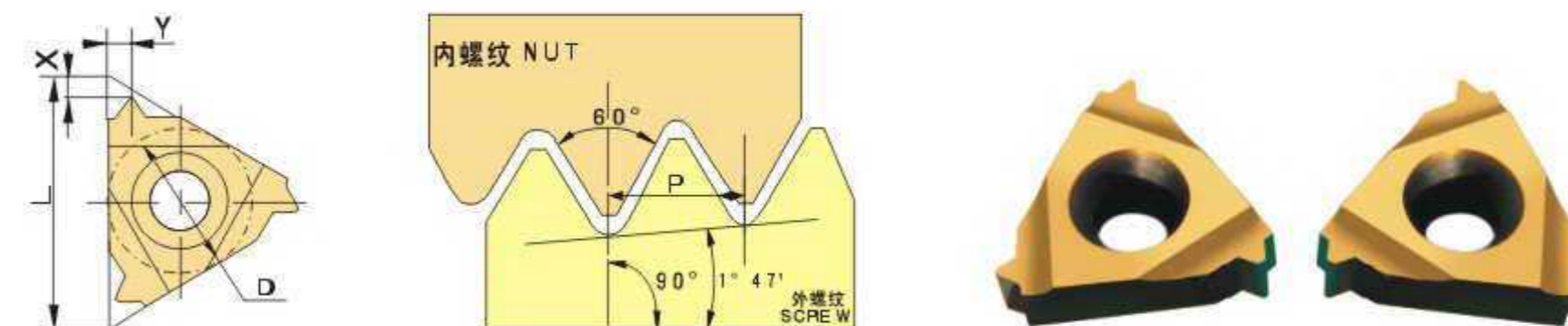
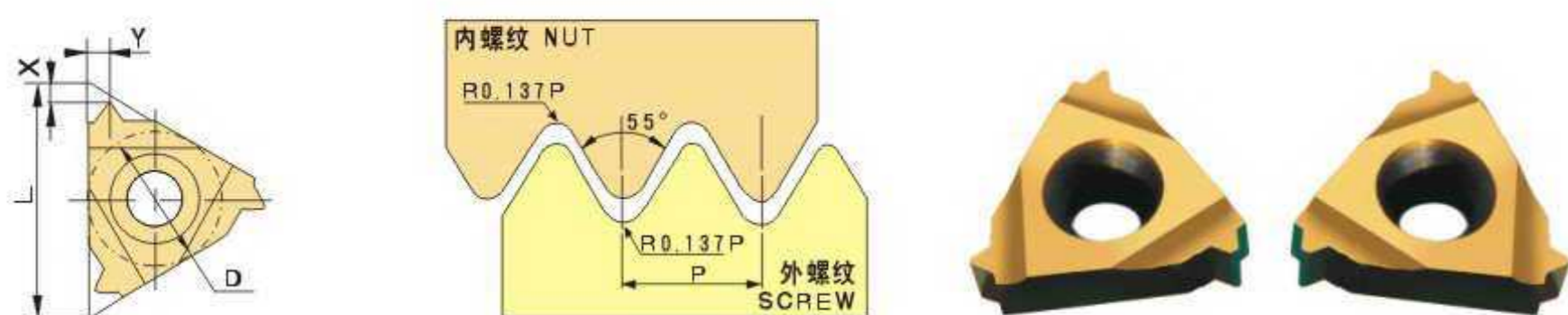

	D	加工螺距 Pitch	刀片型号 Designation		刀片尺寸 Dimension			
			TPI	右旋螺纹 Right Hand	左旋螺纹 Left Hand	L	X	Y
内螺纹 Internal	1/4"	28	11IR28 W	11IL28 W	11	0.6	0.6	
		26	11IR26 W	11IL26 W		0.6	0.7	
		20	11IR20 W	11IL20 W		0.7	0.9	
		19	11IR19 W	11IL19 W		0.8	1.0	
		18	11IR18 W	11IL18 W		0.8	1.0	
		16	11IR16 W	11IL16 W		0.9	1.1	
		14	11IR14 W	11IL14 W		1.0	1.2	
		14	11IR14 W	11IL14 W		1.0	1.2	
	3/8"	28	16IR28 W	16IL28 W	16	0.6	0.7	
		26	16IR26 W	16IL26 W		0.7	0.8	
		20	16IR20 W	16IL20 W		0.8	0.9	
		19	16IR19 W	16IL19 W		0.8	1.0	
		18	16IR18 W	16IL18 W		0.8	1.0	
		16	16IR16 W	16IL16 W		0.9	1.1	
		14	16IR14 W	16IL14 W		1.0	1.2	
		12	16IR12 W	16IL12 W		1.1	1.4	
		11	16IR11 W	16IL11 W		1.1	1.5	
		10	16IR10 W	16IL10 W		1.1	1.5	
		9	16IR9 W	16IL9 W		1.2	1.5	
		8	16IR8 W	16IL8 W		1.2	1.7	
	1/2"	7	22IR7 W	22IL7 W	22	1.6	2.3	
		6	22IR6 W	22IL6 W		1.6	2.3	
		5	22IR5 W	22IL5 W		1.7	2.4	
	5/8"	4.5	27IR4.5 W	27IL4.5 W	27	1.8	2.6	
		4	27IR4 W	27IL4 W		2.0	2.9	

▲ 订货举例: 16IR 16 W 100片

	D	加工螺距 Pitch	刀片型号 Designation		刀片尺寸 Dimension			
			TPI	右旋螺纹 Right Hand	左旋螺纹 Left Hand	L	X	Y
外螺纹 External	1/4"	27	11ER27 NPT	11EL27 NPT	11	0.7	0.8	
		18	11ER18 NPT	11EL18 NPT		0.8	1.0	
		14	11ER14 NPT	11EL14 NPT		0.8	1.0	
		14	11ER14 NPT	11EL14 NPT		0.8	1.0	
	3/8"	27	16ER27 NPT	16EL27 NPT	16	0.7	0.8	
		18	16ER18 NPT	16EL18 NPT		0.8	1.0	
		14	16ER14 NPT	16EL14 NPT		0.9	1.2	
		11.5	16ER11.5 NPT	16EL11.5 NPT		1.1	1.5	
内螺纹 Internal	1/4"	8	16ER8 NPT	16EL8 NPT	11	1.2	1.8	
		27	11IR27 NPT	11IL27 NPT		0.7	0.8	
		18	11IR18 NPT	11IL18 NPT		0.8	1.0	
		14	11IR14 NPT	11IL14 NPT		0.8	1.0	
	3/8"	27	16IR27 NPT	16IL27 NPT	16	0.7	0.8	
		18	16IR18 NPT	16IL18 NPT		0.8	1.0	
		14	16IR14 NPT	16IL14 NPT		0.9	1.2	
		11.5	16IR11.5 NPT	16IL11.5 NPT		1.1	1.5	
	8	16IR8 NPT	16IL8 NPT	1.2	1.8			

▲ 订货举例: 16ER 8NPT 100片





§ 1-4. 蒸汽. 煤气. 供水管螺纹

1-4.1 美制干密封圆锥管螺纹刀片 (NPTF)

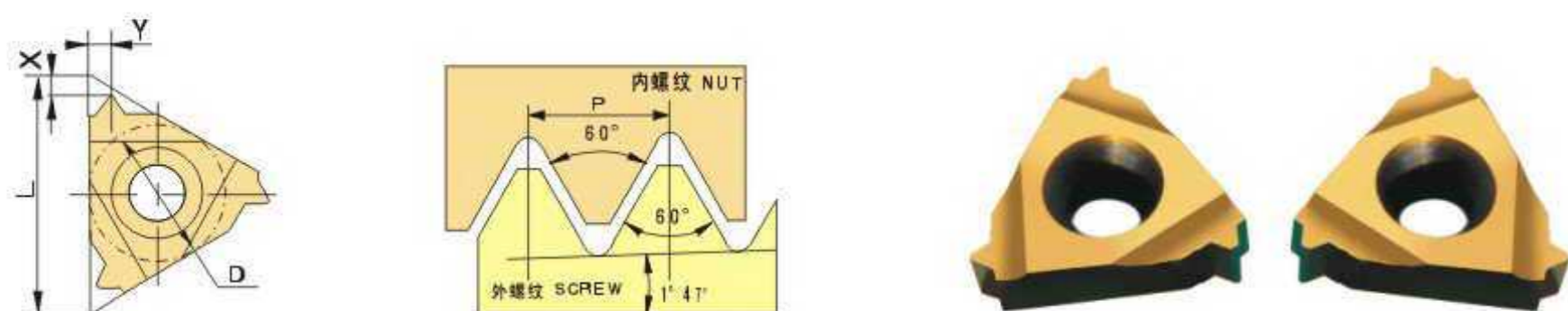

	D	加工螺距 Pitch TPI	刀片型号 Designation		刀片尺寸 Dimension		
			右旋螺纹 Right Hand	左旋螺纹 Left Hand	L	X	Y
外螺纹 External	1/4"	27	11ER 27 NPTF	11EL 27 NPTF	11	0.7	0.8
		18	11ER 18 NPTF	11EL 18 NPTF		0.8	1.0
		14	11ER 14 NPTF	11EL 14 NPTF		0.8	1.0
	3/8"	27	16ER 27 NPTF	16EL 27 NPTF	16	0.7	0.8
		18	16ER 18 NPTF	16EL 18 NPTF		0.8	1.0
		14	16ER 14 NPTF	16EL 14 NPTF		0.9	1.2
11.5		16ER 11.5 NPTF	16EL 11.5 NPTF	1.1		1.5	
内螺纹 Internal	1/4"	8	16ER 8 NPTF	16EL 8 NPTF	11	1.3	1.8
		27	11IR 27 NPTF	11IL 27 NPTF		0.7	0.8
		18	11IR 18 NPTF	11IL 18 NPTF		0.8	1.0
	3/8"	14	11IR 14 NPTF	11IL 14 NPTF	16	0.8	1.0
		27	16IR 27 NPTF	16IL 27 NPTF		0.7	0.8
		18	16IR 18 NPTF	16IL 18 NPTF		0.8	1.0
		14	16IR 14 NPTF	16IL 14 NPTF		0.9	1.2
		11.5	16IR 11.5 NPTF	16IL 11.5 NPTF		1.1	1.5
	8	16IR 8 NPTF	16IL 8 NPTF		1.2	1.8	

▲ 订货举例: 16ER 8NPTF 100片

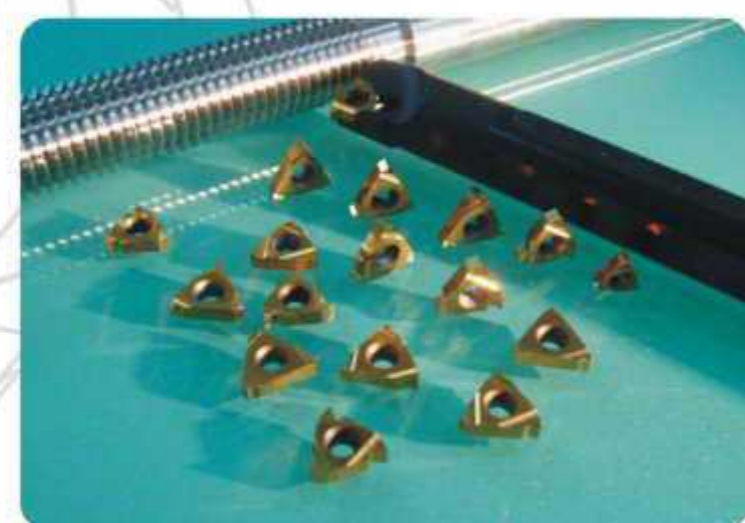

1-4.2 55° 英国标准锥管螺纹刀片(British Standard pipe full profile)

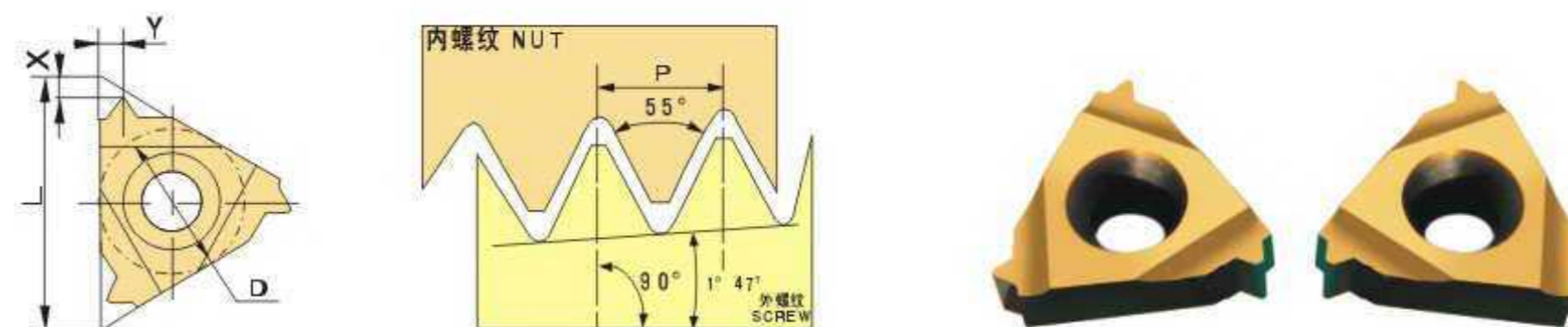

	D	加工螺距 Pitch TPI	刀片型号 Designation		刀片尺寸 Dimension		
			右旋螺纹 Right Hand	左旋螺纹 Left Hand	L	X	Y
外螺纹 External	1/4"	28	11ER 28 BSPT	11EL 28 BSPT	11	0.6	0.6
		19	11ER 19 BSPT	11EL 19 BSPT		0.8	0.9
		14	11ER 14 BSPT	11EL 14 BSPT		0.9	1.0
	3/8"	28	16ER 28 BSPT	16EL 28 BSPT	16	0.6	0.6
		19	16ER 19 BSPT	16EL 19 BSPT		0.8	0.9
		14	16ER 14 BSPT	16EL 14 BSPT		1.0	1.2
11		16ER 11 BSPT	16EL 11 BSPT	1.1		1.5	
内螺纹 Internal	1/4"	28	11IR 28 BSPT	11IL 28 BSPT	11	0.6	0.8
		19	11IR 19 BSPT	11IL 19 BSPT		0.8	0.9
		14	11IR 14 BSPT	11IL 14 BSPT		0.9	1.0
	3/8"	28	16IR 28 BSPT	16IL 28 BSPT	16	0.6	0.6
		19	16IR 19 BSPT	16IL 19 BSPT		0.8	0.9
		14	16IR 14 BSPT	16IL 14 BSPT		1.0	1.2
		11	16IR 11 BSPT	16IL 11 BSPT		1.1	1.5

▲ 订货举例: 16ER 11BSPT 100片



§ 1-5. 机械驱动用

1-5.1 英制29° 梯形螺纹刀片(ACME)

1-5.2 30° 标准梯形螺纹刀片(Trapeze DIN 103)

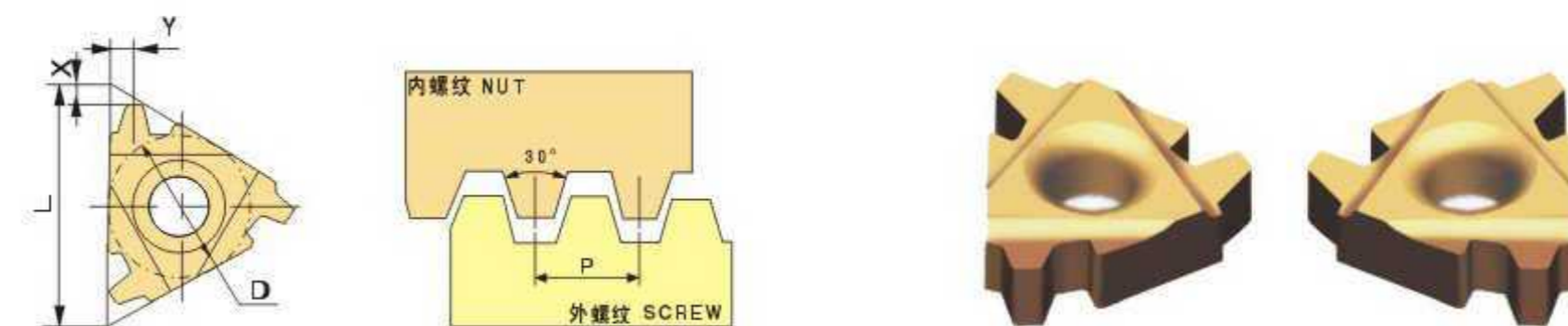
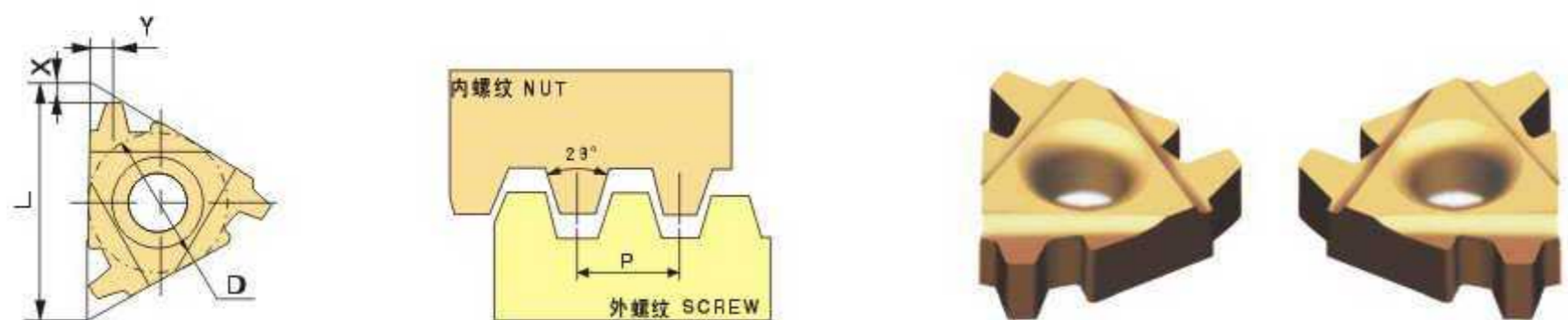

	D	加工螺距 Pitch	刀片型号 Designation		刀片尺寸 Dimension		
		TPI	右旋螺纹 Right Hand	左旋螺纹 Left Hand	L	X	Y
外螺纹 External	3/8"	16	16ER16 ACME	16EL16 ACME	16	1.0	1.1
		14	16ER14 ACME	16EL14 ACME		1.0	1.2
		12	16ER12 ACME	16EL12 ACME		1.1	1.2
		10	16ER10 ACME	16EL10 ACME		1.3	1.3
		8	16ER8 ACME	16EL8 ACME		1.4	1.5
	1/2"	6	22ER6 ACME	22EL6 ACME	22	1.8	2.1
		5	22ER5 ACME	22EL5 ACME		2.0	2.3
5/8"	4	27ER4 ACME	27EL4 ACME	27	2.4	2.7	
内螺纹 Internal	3/8"	16	16IR16 ACME	16IL16 ACME	16	1.0	1.1
		14	16IR14 ACME	16IL14 ACME		1.0	1.2
		12	16IR12 ACME	16IL12 ACME		1.1	1.2
		10	16IR10 ACME	16IL10 ACME		1.3	1.3
		8	16IR8 ACME	16IL8 ACME		1.4	1.5
	1/2"	6	22IR6 ACME	22IL6 ACME	22	1.8	2.1
		5	22IR5 ACME	22IL5 ACME		2.0	2.3
	5/8"	4	27IR4 ACME	27IL4 ACME	27	2.4	2.7

▲ 订货举例：16ER16ACME 100片

	D	加工螺距 Pitch	刀片型号 Designation		刀片尺寸 Dimension		
		mm	右旋螺纹 Right Hand	左旋螺纹 Left Hand	L	X	Y
外螺纹 External	3/8"	1.5	16ER1.5 TR	16EL1.5 TR	16	1.0	1.1
		2.0	16ER2 TR	16EL2 TR		1.1	1.3
		3.0	16ER3 TR	16EL3 TR		1.3	1.5
	1/2"	4.0	22ER4 TR	22EL4 TR	22	1.7	1.9
		5.0	22ER5 TR	22EL5 TR		2.1	2.5
	5/8"	6.0	27ER6 TR	27EL6 TR	27	2.2	2.6
		7.0	27ER7 TR	27EL7 TR		2.3	2.7
内螺纹 Internal	3/8"	1.5	16IR1.5 TR	16IL1.5 TR	16	1.0	1.1
		2.0	16IR2 TR	16IL2 TR		1.1	1.3
		3.0	16IR3 TR	16IL3 TR		1.3	1.5
	1/2"	4.0	22IR4 TR	22IL4 TR	22	1.7	1.9
		5.0	22IR5 TR	22IL5 TR		2.1	2.5
	5/8"	6.0	27IR6 TR	27IL6 TR	27	2.2	2.6
		7.0	27IR7 TR	27IL7 TR		2.3	2.7

▲ 订货举例：16ER1.5TR 100片

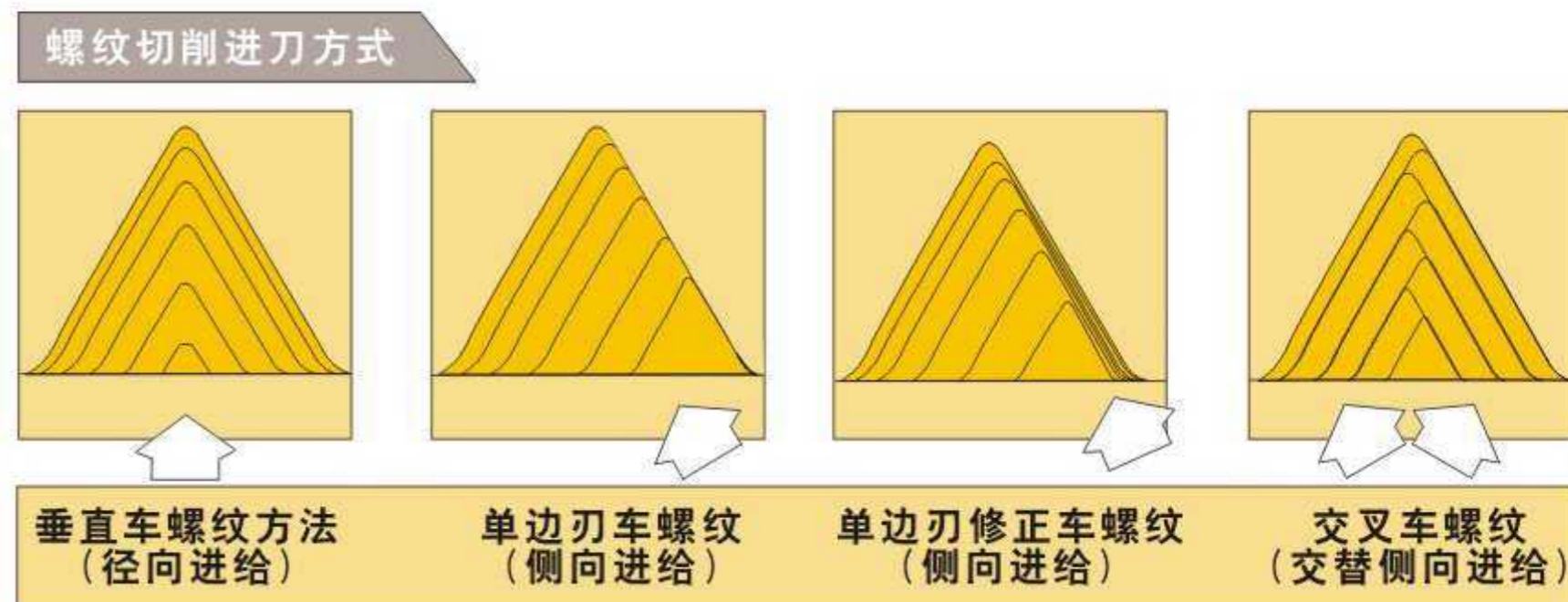

§ 1-6. ABUT-美制锯齿形螺纹刀片 (American Buttress)

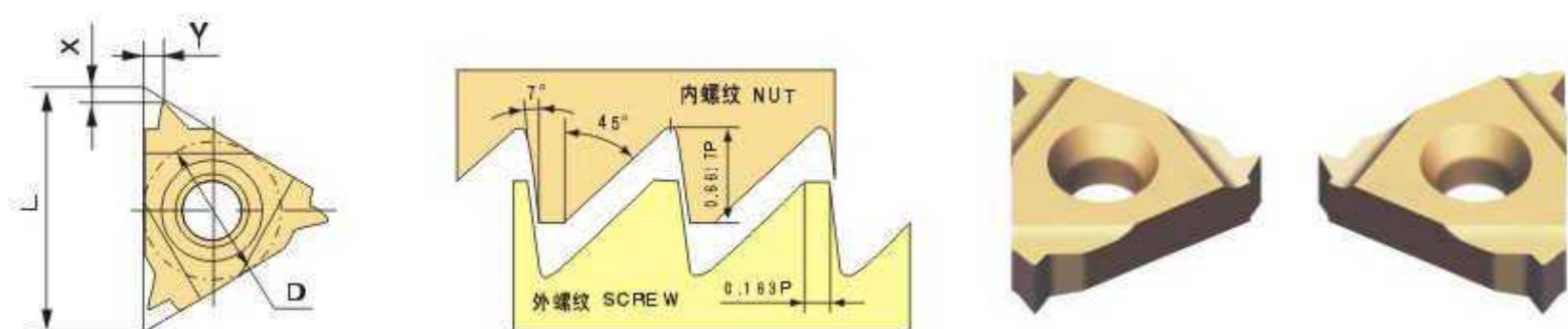

	D	加工螺距 Pitch	刀片型号 Designation		刀片尺寸 Dimension			
		TPI	右旋螺纹 Right Hand	左旋螺纹 Left Hand	L	X	Y	
外螺纹 External	1/4"	20	11ER 20 ABUT	11EL 20 ABUT	11	1.0	1.4	
		16	11ER 16 ABUT	11EL 16 ABUT		1.3	1.9	
	3/8"	20	16ER 20 ABUT	16EL 20 ABUT	16	1.0	1.4	
		16	16ER 16 ABUT	16EL 16 ABUT		1.3	1.9	
		12	16ER 12 ABUT	16EL 12 ABUT		1.4	2.0	
	1/2"	10	16ER 10 ABUT	16EL 10 ABUT	22	1.5	2.3	
8		22ER 8 ABUT	22EL 8 ABUT	2.0		3.2		
内螺纹 Internal	1/4"	6	22ER 6 ABUT	22EL 6 ABUT	22	2.2	3.5	
		20	11IR 20 ABUT	11IL 20 ABUT		11	1.0	1.4
	16	11IR 16 ABUT	11IL 16 ABUT	1.3	1.9			
	3/8"	20	16IR 20 ABUT	16IL 20 ABUT	16	1.0	1.4	
		16	16IR 16 ABUT	16IL 16 ABUT		1.3	1.9	
		12	16IR 12 ABUT	16IL 12 ABUT		1.4	2.0	
	1/2"	10	16IR 10 ABUT	16IL 10 ABUT	22	1.5	2.3	
		8	22IR 8 ABUT	22IL 8 ABUT		2.0	3.2	
			6	22IR 6 ABUT	22IL 6 ABUT		2.2	3.5

▲订货举例: 16ER 12ABUT 100片



§ 1-7. RD 消防食品机械螺纹刀片(Round DIN 405)

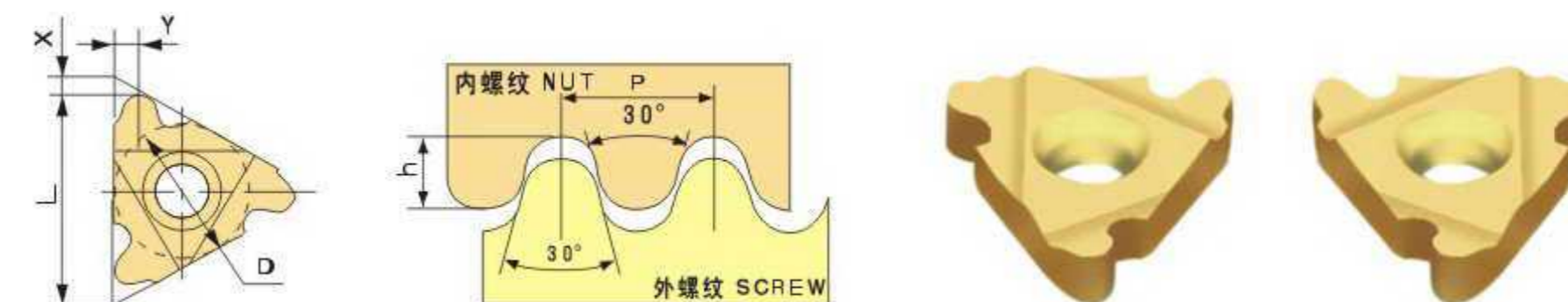

	D	加工螺距 Pitch	刀片型号 Designation		刀片尺寸 Dimension		
		TPI	右旋螺纹 Right Hand	左旋螺纹 Left Hand	L	X	Y
外螺纹 External	3/8"	10	16ER 10 RD	16EL 10 RD	16	1.1	1.2
		8	16ER 8 RD	16EL 8 RD		1.3	1.4
		6	16ER 6 RD	16EL 6 RD		1.5	1.7
	1/2"	6	22ER 6 RD	22EL 6 RD	22	1.5	1.7
		4	22ER 4 RD	22EL 4 RD		1.7	2.3
		4	27ER 4 RD	27EL 4 RD		27	1.7
内螺纹 Internal	3/8"	10	16IR 10 RD	16IL 10 RD	16	1.1	2.2
		8	16IR 8 RD	16IL 8 RD		1.3	1.4
		6	16IR 6 RD	16IL 6 RD		1.5	1.7
	1/2"	6	22IR 6 RD	22IL 6 RD	22	1.5	1.7
		4	22IR 4 RD	22IL 4 RD		1.7	2.3
		4	27IR 4 RD	27IL 4 RD		27	1.7

▲订货举例: 16ER 8RD 100片



第二部分：螺纹刀杆

外螺纹刀杆 External Threading Tool holder

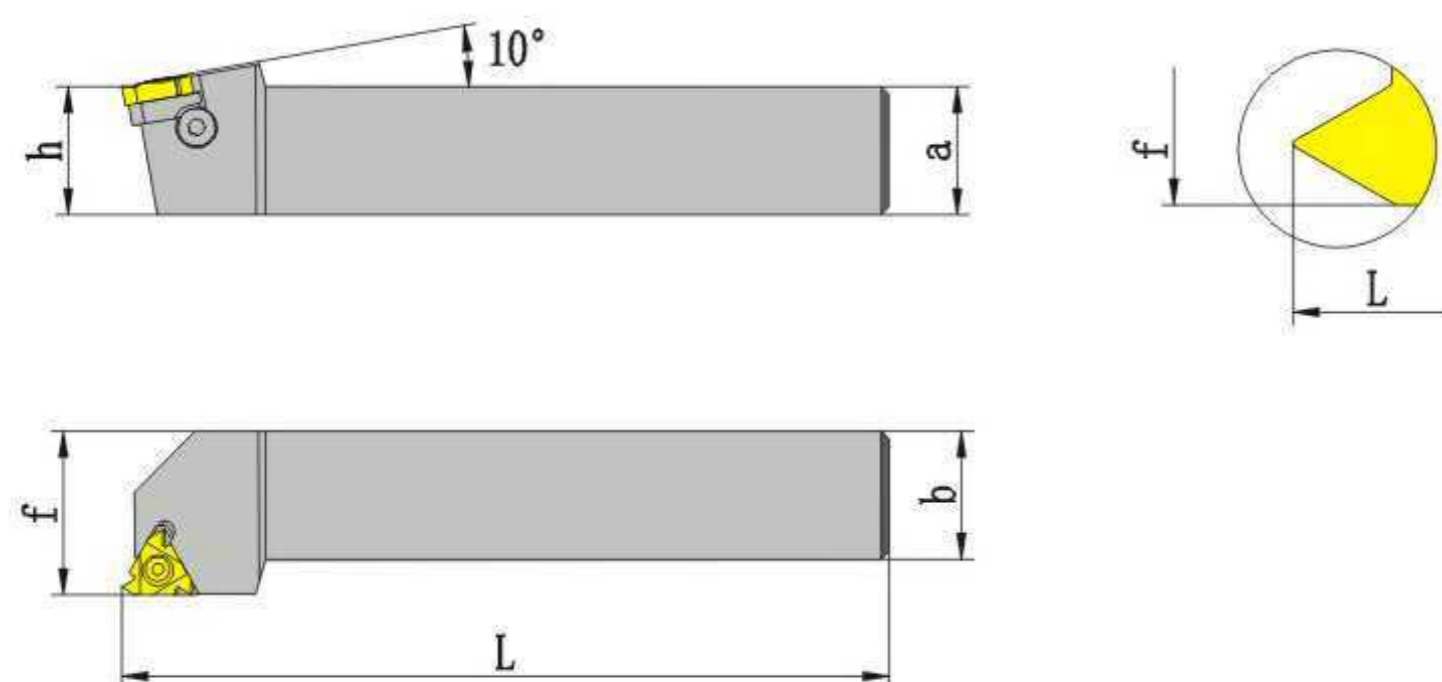

编号	型号	h	a	b	L	f	刀片	螺钉	扳手
1	SER/L1616H16	16	16	16	100	20	16ER/LOOO	M3.5	T15
2	SER/L2020K16	20	20	20	125	25			
3	SER/L2525M16	25	25	25	150	32			
4	SER/L3225P16	32	32	25	170	32			
5	SER/L3232P16	32	32	32	170	40	22ER/LOOO	M4.0	T20
6	SER/L2525M22	25	25	25	150	32			
7	SER/L3225P22	32	32	25	170	32			
8	SER/L3232P22	32	32	32	170	40			

▲定货举例：螺纹刀杆 SER2525M16 1把

内螺纹刀杆 Internal Threading Tool holder

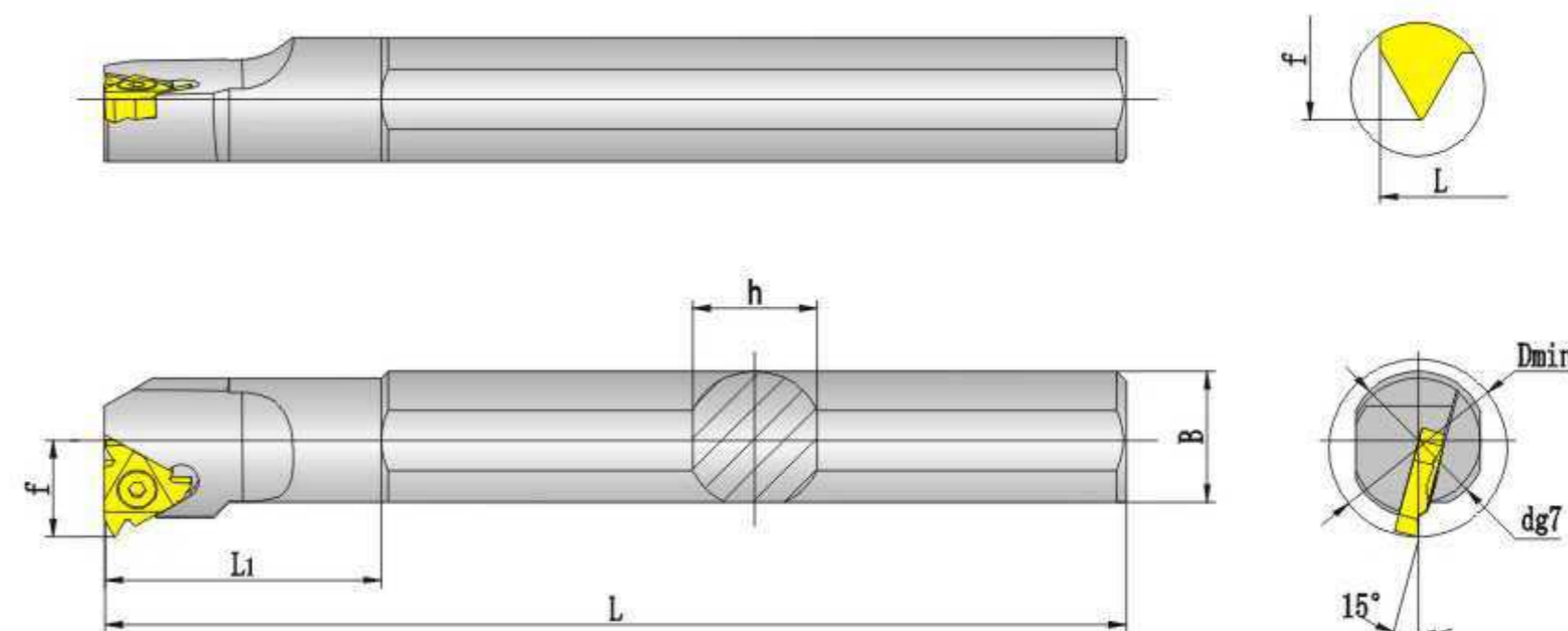

编号	型号	d	f	L	h	加工直径 Dmin	B	L1	刀片	螺钉	扳手
1	SNR/L0010H11	10	7	100	9	12	9	25	11IR/LOOO	M2.5	T8
2	SNR/L0012K11	12	9	125	11	16	11.5	32			
3	SNR/L0016M16	16	12	150	15	20	15.5	32	16IR/LOOO	M3.5	T15
4	SNR/L0020P16	20	14	180	18	25	19	40			
5	SNR/L0025M16	25		150	23	30	24	40			
6	SNR/L0032S16	32		250	30	37	30	55			
7	SNR/L0050U16	50		300	47	60	47		22IR/LOOO	M4.0	T20
8	SNR/L0032S22	32		250	30	37	30	55			
9	SNR/L0050U22	50		300	47	60	47				

▲定货举例：螺纹刀杆 SNR0020P16 1把